

Canali per installazione completo di coperchio smontabile con attrezzo (secondo norme DIN).

2.4.2

Installation trunking, including cover removable by tool (in accordance with DIN standards).

Dati Tecnici
Technical data

2.4.14

LINEADIN LDC.
Elementi del sistema a parete.
Wall system components.

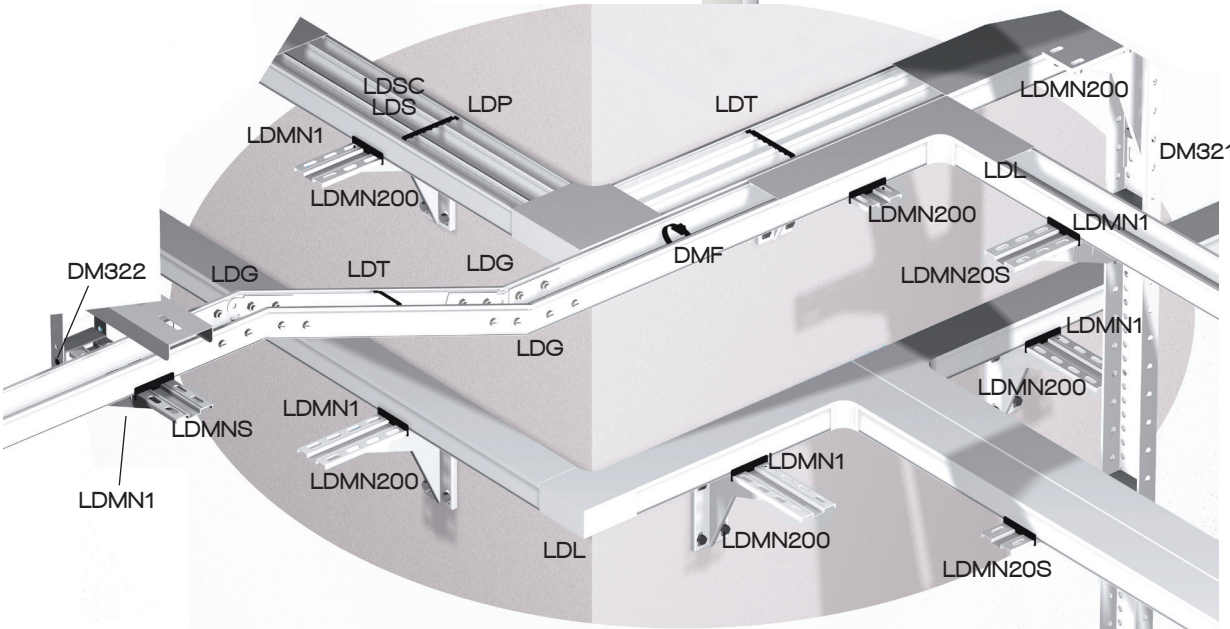
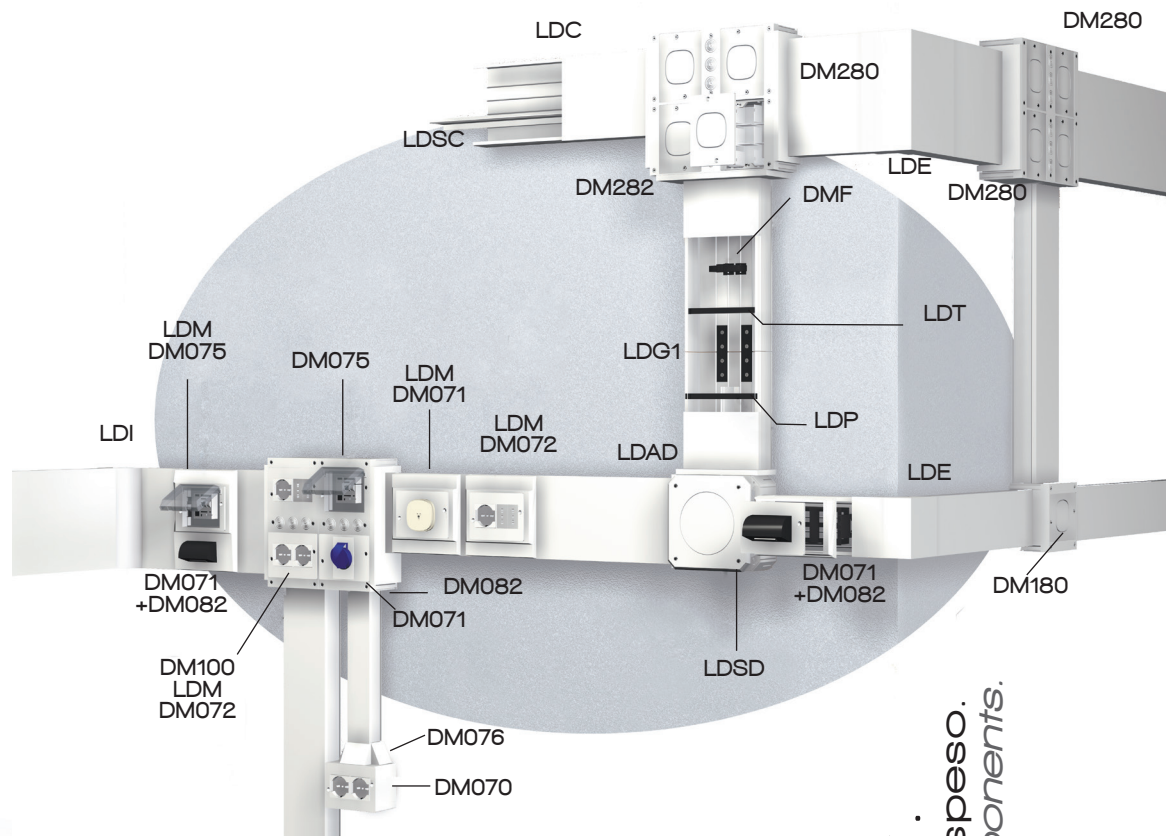

LINEADIN LDC.
Elementi del sistema sospeso.
Suspension system components.

Canali per installazione completo di coperchio smontabile con attrezzo (secondo norme DIN). Modulo 12,5

Materiale: PVC Rigido Autoestinguente Classe 1 (UL94-V0).

Lunghezza: 2 metri

I canali vengono forniti completi di coperchio.

Colore: Bianco tipo 9010

Installation trunking, including cover removable by tool (in accordance with DIN standards). Mod. 12,5









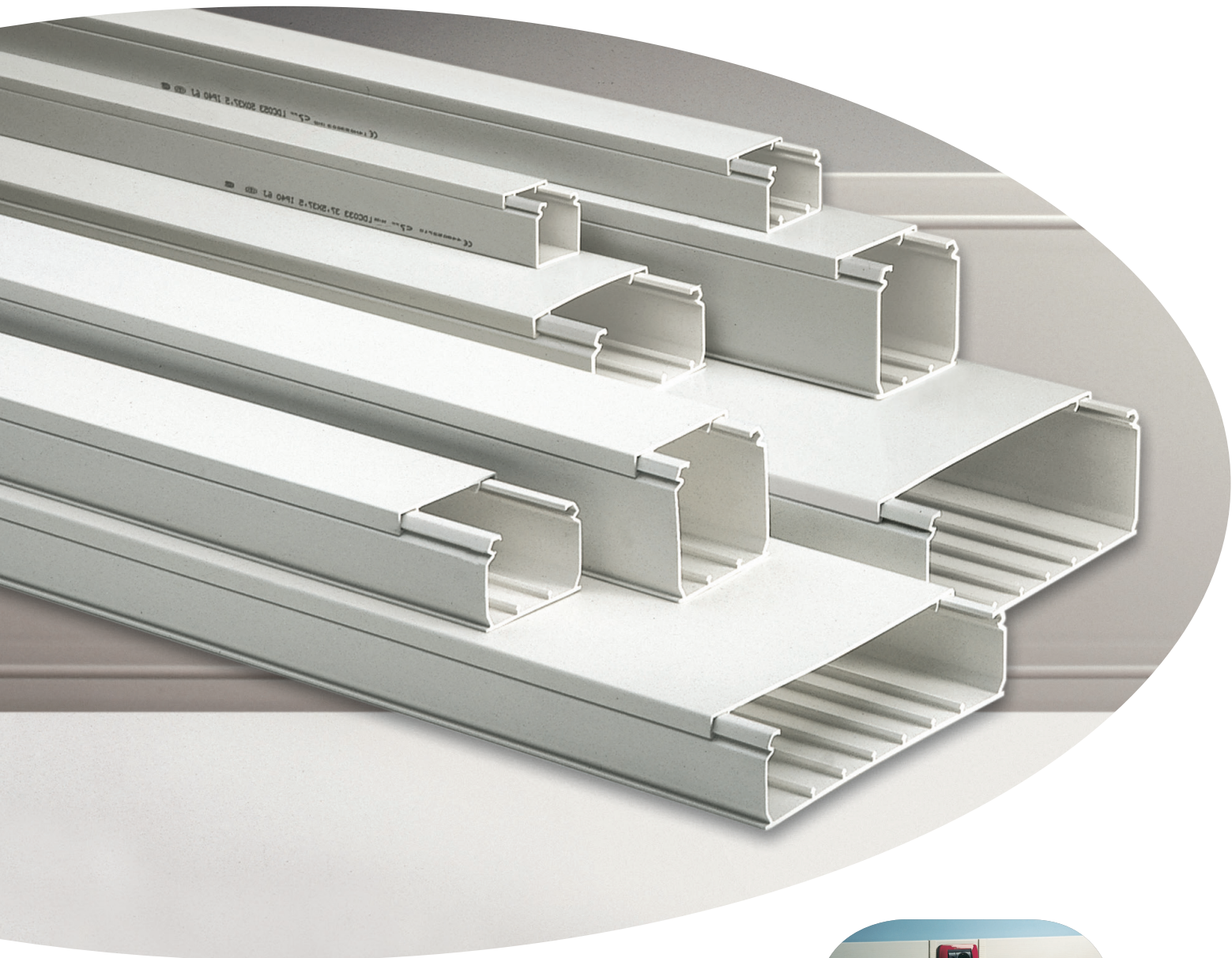





Self-extinguishing rigid PVC Class 1 (UL94-V0).

Length: 2 meters

All trunkings come complete with cover.

Colour : White type 9010



Guide Rails	Sezione fondo Section of the bottom	Codice Code	Dimensioni BxH mm Duct Size BxH mm	Imballo m Standard Carton m	S.G. mm ² G.S. mm ²	Lung. barre m Length m	Cartone peso Kg Carton Weight Kg
		LDC022BEU	25x25	80	440	2	18,4
		LDC032BEU	37,5x25	52	645	2	17
		LDC033BEU	37,5x37,5	36	1075	2	14,5
▲		LDC053BEU	50x37,5	28	1520	2	14,4
▲		LDC055BEU	50x50	24	2126	2	14
▲		LDC075BEU	75x50	20	3115	2	18
▲		LDC105BEU	100x50	16	4270	2	16,6
▲		LDC125BEU	125x50	20	5350	2	24,7
▲		LDC155BEU	150x50	12	6320	2	18,4
▲		LDC205BEU	200x50	12	8590	2	23,8
▲		LDC077BEU	75x75	20	4890	2	21,9
▲		LDC107BEU	100x75	16	6670	2	21,3
▲		LDC127BEU	125x75	12	8350	2	18,6
▲		LDC157BEU	150x75	8	9945	2	14,5
▲		LDC207BEU	200x75	8	13465	2	18

▲ Canali con guide sul fondo. / Trunkings with rails on the bottom.

Sezione piana  Flat section

Sezione con guida  Section with rail

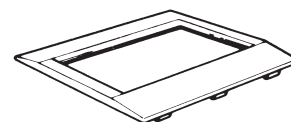
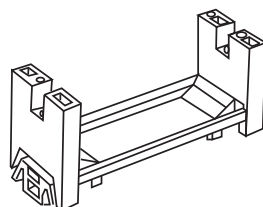
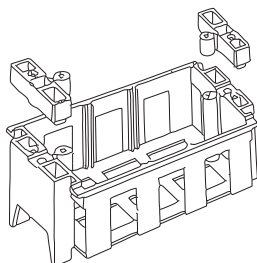
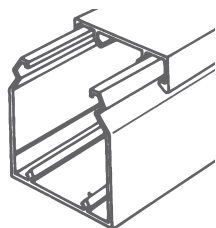

Scatola portautenze per apparecchi con interasse 60 e 83,5mm interne ai canali.
Socket point to be installed inside trunking with centres 60 and 83,5 mm.

Portapparecchi modulari 17,5 (max 5) e morsetti.
Modular switches (17,5 - maximum n° 5) and clamps holder.

Placche portamostrine. Permettono il montaggio delle mostrine DM071 - DM072 - DM073 - DM0736 - DM075.
Front plate holder. They allow assembly of the DM071 - DM072 - DM073 - DM0736 - DM075 panels.

Guide Rails	Codice Code	BxH mm BxH mm
-------------	-------------	---------------

	LDC022BEU	25x25
	LDC032BEU	37,5x25
	LDC033BEU	37,5x37,5
▲	LDC053BEU	50x37,5
▲	LDC055BEU	50x50
▲	LDC075BEU	75x50
▲	LDC105BEU	100x50
▲	LDC125BEU	125x50
▲	LDC155BEU	150x50
▲	LDC205BEU	200x50
▲	LDC077BEU	75x75
▲	LDC107BEU	100x75
▲	LDC127BEU	125x75
▲	LDC157BEU	150x75
▲	LDC207BEU	200x75

Codice Code	Imballo pz. Packing pcs.
-------------	--------------------------

DM100	15
DM100	15
DM100	15
DM100	15

Codice Code	Imballo pz. Packing pcs.
-------------	--------------------------

DM105	15
DM105	15
DM105	15
DM105	15

Codice Code	Imballo pz. Packing pcs.
-------------	--------------------------

LDM105BEU	15
LDM125BEU	15
LDM155BEU	15
LDM205BEU	15

▲ Canali con guide sul fondo. / Trunkings with rails on the bottom.

■ = Nero / Black Type 9017 □ BEU = Bianco / White Type 9010

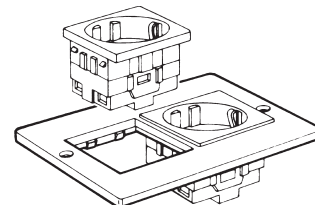
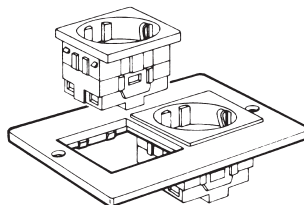
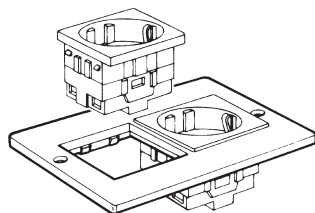
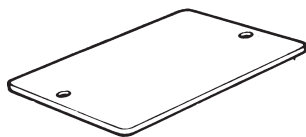

DM071

Mostrina cieca per presa telefonica e accessorio DM082.

Closed plate for lt. phone socket and DM082 accessory.

DM072TT

Mostrina per il montaggio di N. 2 prese SCHUKO e moduli singoli per TICINO TT MAGIC

Plate for mounting of 2 SCHUKO sockets and single modules for TICINO TT MAGIC.

DM072VIP

Mostrina per il montaggio di N. 2 prese SCHUKO e moduli singoli per VIMAR PLANA.

Plate for mounting of 2 SCHUKO sockets and single modules for VIMAR PLANA.

DM072AV

Mostrina per il montaggio di N. 2 prese SCHUKO e moduli singoli per AVE - Blanc/Noir

Plate for mounting of 2 SCHUKO sockets and single modules for AVE - Blanc/Noir.

Codice Code	Imballo pz. Packing pcs.
----------------	-----------------------------

Codice Code	Imballo pz. Packing pcs.
----------------	-----------------------------

Codice Code	Imballo pz. Packing pcs.
----------------	-----------------------------

Codice Code	Imballo pz. Packing pcs.
----------------	-----------------------------

DM071BEU	20
DM071BEU	20
DM071BEU	20
DM071BEU	20

DM072TTBE	20
DM072TTBE	20
DM072TTBE	20
DM072TTBE	20

DM072VIPBE	20
DM072VIPBE	20
DM072VIPBE	20
DM072VIPBE	20

DM072AVBE	20
DM072AVBE	20
DM072AVBE	20
DM072AVBE	20

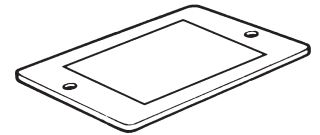
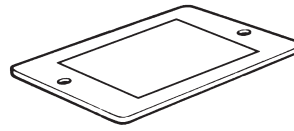
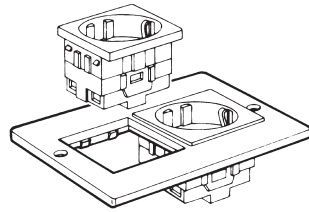
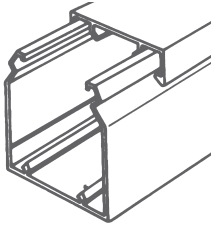

Mostrina per il montaggio di 2 prese SCHUKO e moduli singoli per GEWISS serie 20.
Plate for mounting of 2 SCHUKO sockets and single modules for GEWISS 20 series.

Mostrina per utenze con interasse 83,5 (3 mod.).
Plate for sockets with centres of 83,5 mm (3 mod.).

Mostrina per utenze con interasse 55/60 mm (2 mod.).
Plate for sockets with centres distance of 55/60 mm (2 mod.).

Guide Rails	Codice Code	BxH mm BxH mm
-------------	-------------	---------------

Codice Code	Imballo pz. Packing pcs.
-------------	--------------------------

Codice Code	Imballo pz. Packing pcs.
-------------	--------------------------

Codice Code	Imballo pz. Packing pcs.
-------------	--------------------------

	LDC022BEU	25x25
	LDC032BEU	37,5x25
	LDC033BEU	37,5x37,5
▲	LDC053BEU	50x37,5
▲	LDC055BEU	50x50
▲	LDC075BEU	75x50
▲	LDC105BEU	100x50
▲	LDC125BEU	125x50
▲	LDC155BEU	150x50
▲	LDC205BEU	200x50
▲	LDC077BEU	75x75
▲	LDC107BEU	100x75
▲	LDC127BEU	125x75
▲	LDC157BEU	150x75
▲	LDC207BEU	200x75

DM072GWBE	20
DM072GWBE	20
DM072GWBE	20
DM072GWBE	20
DM072GWBE	20

DM073BEU	20
DM073BEU	20
DM073BEU	20
DM073BEU	20
DM073BEU	20

DM0736BEU	20
DM0736BEU	20
DM0736BEU	20
DM0736BEU	20
DM0736BEU	20

▲ Canali con guide sul fondo. / Trunkings with rails on the bottom.

■ = Nero / Black Type 9017

□ = Grigio chiaro / Light grey Type 7035

□ BEU = Bianco / White Type 9010

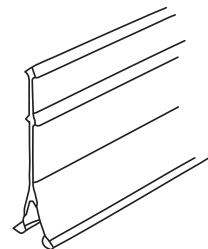
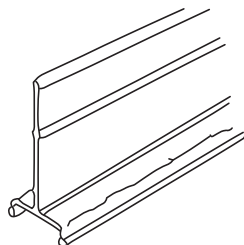
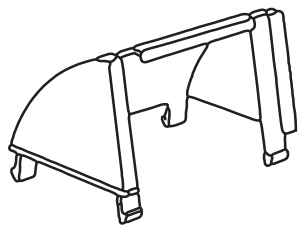
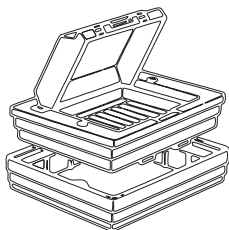

DM075

Mostrina per magnetotermici orizzontali (max 5).

Plate for horizontal MCB switches (max 5).

DM082

Adattatore per connettori EDP.

It. socket adaptor.

LDSC

Separatore centrale.

Lunghezza barre: 1 m

Central separator. Length: 1 m.

LDS

Separatore laterale.

Lunghezza barre: 1 m

Lateral separator. Length: 1 m.

Codice Code	Imballo pz. Packing pcs.
----------------	-----------------------------

DM075BEU	10
DM075BEU	10
DM075BEU	10

Codice Code	Imballo pz. Packing pcs.
----------------	-----------------------------

DM082	20

Codice Code	Imballo m. Packing m.
----------------	--------------------------

LDSC50	50
LDSC50	50
LDSC50	50
LDSC50	50
LDSC50	50
LDSC75	25
LDSC75	25
LDSC75	25
LDSC75	25
LDSC75	25
LDSC75	25

Codice Code	Imballo m. Packing m.
----------------	--------------------------

LDS50	50
LDS50	50
LDS50	50
LDS50	50
LDS50	50
LDS75	50
LDS75	50
LDS75	50
LDS75	50
LDS75	50
LDS75	50

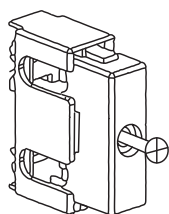
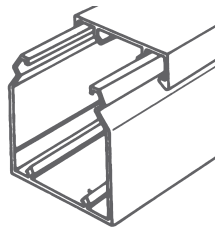

Fermacavo universale per canali Tipo G, LDC e Dominio.
Cable fastener for Tipo G, LDC and Dominio

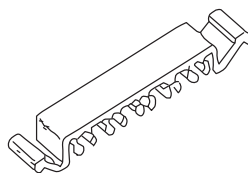

Traversino per separatore.
Cross arm for separator.

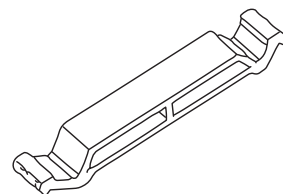

Traversino per contenimento cavi.
Cross arm for cables retention.

Guide Rails	Codice Code	BxH mm BxH mm
----------------	----------------	------------------

	LDC022BEU	25x25
	LDC032BEU	37,5x25
	LDC033BEU	37,5x37,5
▲	LDC053BEU	50x37,5
▲	LDC055BEU	50x50
▲	LDC075BEU	75x50
▲	LDC105BEU	100x50
▲	LDC125BEU	125x50
▲	LDC155BEU	150x50
▲	LDC205BEU	200x50
▲	LDC077BEU	75x75
▲	LDC107BEU	100x75
▲	LDC127BEU	125x75
▲	LDC157BEU	150x75
▲	LDC207BEU	200x75

Codice Code	Imballo pz. Packing pcs.
----------------	-----------------------------

FMC	40 (4x10)
FMC	40 (4x10)
FMC	40 (4x10)
FMC	40 (4x10)
FMC	40 (4x10)
FMC	40 (4x10)
FMC	40 (4x10)
FMC	40 (4x10)
FMC	40 (4x10)
FMC	40 (4x10)
FMC	40 (4x10)
FMC	40 (4x10)
FMC	40 (4x10)

Codice Code	Imballo pz. Packing pcs.
----------------	-----------------------------

LDP50	500 (5x100)
LDP75	300 (3x100)
LDP100	150 (2x75)
LDP125	130 (2x65)
LDP150	50
LDP200	50
LDP75	300 (3x100)
LDP100	150 (2x75)
LDP125	130 (2x65)
LDP150	50
LDP200	50

Codice Code	Imballo pz. Packing pcs.
----------------	-----------------------------

LDT50	500 (5x100)
LDT50	500 (5x100)
LDT75	300 (3x100)
LDT100	200 (2x100)
LDT125	150 (2x75)
LDT150	50
LDT200	50
LDT75	300 (3x100)
LDT100	200 (2x100)
LDT125	150 (2x75)
LDT150	50
LDT200	50

▲ Canali con guide sul fondo. / Trunkings with rails on the bottom.

□ BEU = Bianco / White Type 9010 ■ = Nero / Black Type 9017

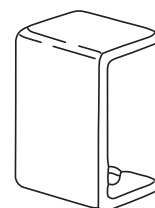
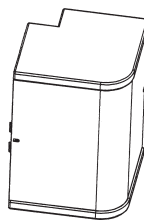
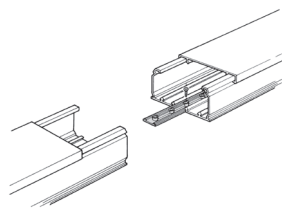
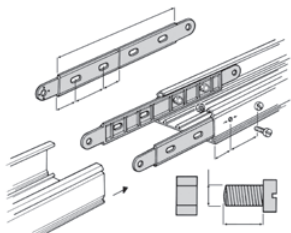

Giunto canali e snodo.
Utilizza viti e dadi Ø 8.
*Trunking joint and articulated coupling.
To be used with Ø 8 screws and nuts.*

Giunto collegamento fondo canali. Utilizza viti autofilettanti (nella confezione).
Joint for connecting the base of the trunkings. Uses self-tapping screws (in the packing).

Angolo esterno.
Outer bend.

Giunto coperchio.
Cover joint.

Codice Code	Imballo pz. Packing pcs.
----------------	-----------------------------

Codice Code	Imballo pz. Packing pcs.
----------------	-----------------------------

Codice Code	Imballo pz. Packing pcs.
----------------	-----------------------------

Codice Code	Imballo pz. Packing pcs.
----------------	-----------------------------

LDG50	20
LDG50	20
LDG50	20
LDG50	20
LDG50	20
LDG50	20
LDG50	20
LDG50	20
LDG75	20
LDG75	20
LDG75	20
LDG75	20
LDG75	20

LDG 1	25 (5x5)
LDG 1	25 (5x5)
LDG 1	25 (5x5)
LDG 1	25 (5x5)
LDG 1	25 (5x5)
LDG 1	25 (5x5)
LDG 1	25 (5x5)
LDG 1	25 (5x5)
LDG 1	25 (5x5)
LDG 1	25 (5x5)
LDG 1	25 (5x5)
LDG 1	25 (5x5)
LDG 1	25 (5x5)

LD022EBEU	25
LD032EBEU	20
LD033EBEU	20
LD053EBEU	16
LD055EBEU	16
LD075EBEU	16
LD106EBEU	15
LD125EBEU	10
LD155EBEU	4
LD205EBEU	4
LD077EBEU	16
LD107EBEU	4
LD127EBEU	4
LD157EBEU	4
LD207EBEU	4

LD022GBEU	25
LD032GBEU	20
LD033GBEU	20
LD053TBEU ◦	12
LD055TBEU ◦	12
LD075TBEU ◦	12
LD106GBEU	30
LD125GBEU	30
LD155GBEU	30
LD205GBEU	30
LD077GBEU *	20
LD107GBEU	30
LD127GBEU	30
LD157GBEU	30
LD207GBEU	30

* = Fornibile a richiesta e per quantità da concordare
Available on request and for quantities to be agreed

◦ = Utilizza giunto derivazione a T-LDT
Get from 'T' joint LDT

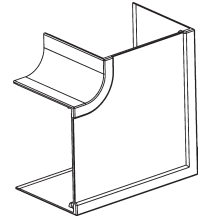
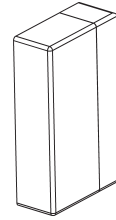
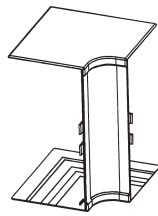
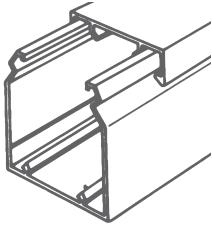

LD I

LD A

LD L

Angolo interno.
Inner bend.

Tappo terminale.
End cap.

Giunto per derivazione piana.
L-joint for wall deviations.

Guide Rails	Codice Code	BxH mm BxH mm
----------------	----------------	------------------

Codice Code	Imballo pz. Packing pcs.
----------------	-----------------------------

Codice Code	Imballo pz. Packing pcs.
----------------	-----------------------------

Codice Code	Imballo pz. Packing pcs.
----------------	-----------------------------

	LDC022BEU	25x25
	LDC032BEU	37,5x25
	LDC033BEU	37,5x37,5
▲	LDC053BEU	50x37,5
▲	LDC055BEU	50x50
▲	LDC075BEU	75x50
▲	LDC105BEU	100x50
▲	LDC125BEU	125x50
▲	LDC155BEU	150x50
▲	LDC205BEU	200x50
▲	LDC077BEU	75x75
▲	LDC107BEU	100x75
▲	LDC127BEU	125x75
▲	LDC157BEU	150x75
▲	LDC207BEU	200x75

LD022IBEU	25
LD032IBEU	20
LD033IBEU	20
LD053IBEU	12
LD055IBEU	12
LD075IBEU	16
LD105IBEU	15
LD125IBEU	10
LD155IBEU	10
LD205IBEU	4
LD077IBEU	15
LD107IBEU	4
LD127IBEU	4
LD157IBEU	4
LD207IBEU	4

LD022ABEU	25
LD032ABEU	20
LD033ABEU	20
LD053ABEU	20
LD055ABEU	20
LD075ABEU	20
GT100ABEU ▲	10
LD127ABEU ▲	10
LD155ABEU	10
LD205ABEU	10
LD077ABEU	10
GT100ABEU ▲	10
LD127ABEU	10
LD157ABEU	10
LD207ABEU	10

LD022LBEU	25
LD032LBEU	20
LD033LBEU	20
LD053LBEU	16
LD055LBEU	16
LD075LBEU	20
LD105LBEU	10
LD125LBEU	8
LD155LBEU	10
LD205LBEU	4
LD077LBEU*	10
LD107LBEU*	4
LD127LBEU*	4
LD157LBEU	4
LD207LBEU	4

▲ Canali con guide sul fondo. / Trunkings with rails on the bottom.

□ BEU = Bianco / White Type 9010

▲ = Ricavare dalla misura più grande * = Fornibile a richiesta e per quantità da concordare
Get from bigger sizes Available on request and for quantities to be agreed

2.4.10



www.canalplast.it - info@canalplast.it

INSTALLAZIONI / INSTALLATIONS

CANALPLAST

MINICANALI, CANALI PER IMPIANTI, CANALI PORTAUTENZE
MINITRUNKINGS, CABLE DUCTINGS, INSTALLATION TRUNKINGS

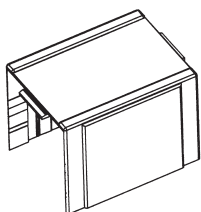

LD T

Giunto derivazione a T.
T-joint wall deviations.

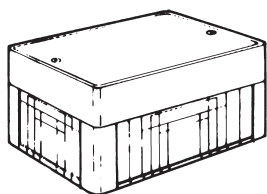

DM070

Pag/Page 4.1.6

Scatola di derivazione e portautenze completa di:
- 1 Mostrina DM071
- 2 Viti metalliche
- 1 Accessorio non promiscuità cavi
Junction box and socket point complete with:
- 1 DM071 plate
- 2 Metal screws
- 1 Cable non-contact accessory

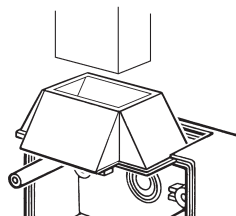

DM076

Pag/Page 4.1.6

Adattatore per DM070. Si utilizza con canali aventi larghezza ≤ 60 e con tubo di Ø esterno max 20 mm
DM070 adaptor. Use with trunkings width ≤60 and one pipe of outer Ø max 20 mm.

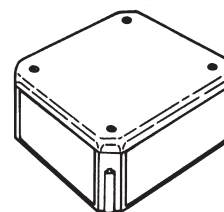

LDSD

Pag/Page 4.1.8

Scatola di derivazione per canali max 125x50/75, min 50x50/75 mm. Completa di separatori cavi e pareti laterali.
Junction box for trunkings max 125x50/75, min 50x50/75 mm. Complete with cable separation and wall sides.

Codice Code	Imballo pz. Packing pcs.
----------------	-----------------------------

Codice Code	Imballo pz. Packing pcs.
----------------	-----------------------------

Codice Code	Imballo pz. Packing pcs.
----------------	-----------------------------

Codice Code	Imballo pz. Packing pcs.
----------------	-----------------------------

LD022TBEU	25
LD032TBEU	20
LD033TBEU	20
LD053TBEU	12
LD055TBEU	12
LD075TBEU	12
LD105TBEU	15
LD125TBEU	10
LD155TBEU	10
LD205TBEU	8
LD077TBEU	10
LD107TBEU	4
LD127TBEU	4
LD157TBEU	4
LD207TBEU	4

DM070BEU	5
DM070BEU	5
DM070BEU	5
DM070BEU	5

DM076BEU	10
DM076BEU	10
DM076BEU	10
DM076BEU	10

LDSDBEU	4
LDSDBEU	4
LDSDBEU	4
LDSDBEU	4
LDSDBEU	4
LDSD75BEU	3
LDSD75BEU	3
LDSD75BEU	3

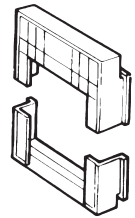
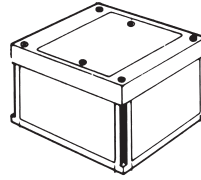
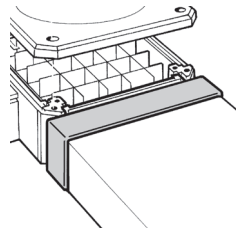
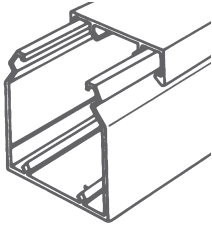

LDAD Pag./Page 4.1.9

DM180 Pag./Page 4.1.7

DM2821 Pag./Page 4.1.8

Adattatore per derivare dalla scatola LDSD canali LDC 150x50.

Adaptor for junction between LDSD box and LDC trunkings 150x50.

Scatola di derivazione e portautenze completa di:

- 1 Accessorio non promiscuità cavi
- 1 Mostrina DM071
- 4 Pareti laterali
- 6 Viti di fissaggio

Modular junction box and socket point complete with:

- 1 Cable non-contact accessory
- 4 Side section
- 1 DM071 plate
- 6 Fixing screws

Adattatore per canali alla scatola DM180.

Adaptor for trunking to the DM180 box. L max = 100 mm H max = 80 mm

Guide Rails	Codice Code	BxH mm BxH mm
-------------	-------------	---------------

	LDC022BEU	25x25
	LDC032BEU	37,5x25
	LDC033BEU	37,5x37,5
▲	LDC053BEU	50x37,5
▲	LDC055BEU	50x50
▲	LDC075BEU	75x50
▲	LDC105BEU	100x50
▲	LDC125BEU	125x50
▲	LDC155BEU	150x50
▲	LDC205BEU	200x50
▲	LDC077BEU	75x75
▲	LDC107BEU	100x75
▲	LDC127BEU	125x75
▲	LDC157BEU	150x75
▲	LDC207BEU	200x75

Codice Code	Imballo pz. Packing pcs.
-------------	--------------------------

LDADBEU	16

Codice Code	Imballo pz. Packing pcs.
-------------	--------------------------

DM180BEU	12
DM180BEU	12
DM180BEU	12
DM180BEU	12
DM180BEU	12
DM180BEU	12
DM180BEU	12
DM180BEU	12

Codice Code	Imballo pz. Packing pcs.
-------------	--------------------------

DM2821BEU	10
DM2821BEU	10
DM2821BEU	10
DM2821BEU	10
DM2821BEU	10
DM2821BEU	10

▲ Canali con guide sul fondo. / Trunkings with rails on the bottom.

□ BEU = Bianco / White Type 9010 ■ = Nero / Black Type 9017

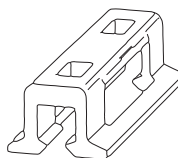
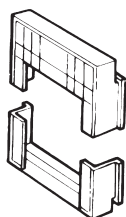
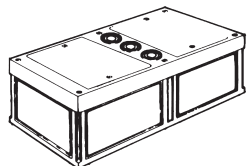

DM280
Pag/Page 4.1.7

Scatola derivazione e portautenze modulare doppia completa di:

- 6 Adattatori - 2 Mostrine DM071
- 2 Accessori non promiscuità cavi
- 2 Perni DM286 - 10 Viti di fissaggio

Modular double junction box and socket point complete with:

- 2 Cable non-contact accessories
- 6 Side section - 2 DM071 plates
- 2 DM286 pivots - 10 Fixing screws

DM2822
Pag/Page 4.1.8

Adattatore per canali alla scatola DM280.

Adaptor for trunking to the DM280 box.

L max = 100 (200) mm

H max = 80 mm

DMF

Portafascette.

Cable-tie holder.

Codice Code	Imballo pz. Packing pcs.
----------------	-----------------------------

DM280BEU	6
DM280BEU	6
DM280BEU	6
DM280BEU	6
DM280BEU	6
DM280BEU	6

Codice Code	Imballo pz. Packing pcs.
----------------	-----------------------------

DM2822BEU	10
DM2822BEU	10
DM2822BEU	10
DM2822BEU	10
DM2822BEU	10
DM2822BEU	10

Codice Code	Imballo pz. Packing pcs.
----------------	-----------------------------

DMF	100 (2X50)
DMF	100 (2X50)
DMF	100 (2X50)
DMF	100 (2X50)
DMF	100 (2X50)
DMF	100 (2X50)
DMF	100 (2X50)
DMF	100 (2X50)
DMF	100 (2X50)
DMF	100 (2X50)
DMF	100 (2X50)
DMF	100 (2X50)
DMF	100 (2X50)
DMF	100 (2X50)

SEZIONE GEOMETRICA E CONTENENZA CAVI.
GEOMETRIC SECTION AND CABLES CONTAINMENT.

LINEADIN

Dati tecnici
Technical data

	LINEADIN BxH mm	S.G / S. G mm ²	Quantità cavi / Quantity of cables mm ²		
			1	1,5	2,5
H 25	25x25	440	42	31	22
	37,5x25	645	61	45	32
H 37,5	37,5x37,5	1075	102	75	54
	50x37,5	1520	144	106	76
H 50	50x50	2126	202	149	106
	75x50	3115	296	218	156
	100x50	4270	406	299	214
	125x50	5350	509	375	268
	150x50	6320	601	443	316
	200x50	8590	817	602	430
H 75	75x75	4890	465	342	245
	100x75	6670	634	467	334
	125x75	8350	794	585	418
	150x75	9945	945	696	497
	200x75	13465	1280	943	673

DATI TECNICI CARICHI DEL CANALE.
TRUNKING LOADS TECHNICAL DATA.

Canale / Trunking L	LDC075BEU		LDC105BEU		LDC125BEU		LDC155BEU		LDC205BEU	
	Q	f	Q	f	Q	f	Q	f	Q	f
500	76	4	79	3,6	81	3,5	83,5	3,4	85	3,3
1000	25	10	27	10	29	10	31	10	33	10
1500	11	15	12	15	13	15	14	15	15	15
2000	6	20	7	20	7	20	8	20	8	20
2500	4	25	4,5	25	4,5	25	5	25	5	25
*Carico /Load Q daN/m	2,3		3,1		3,9		4,8		6,3	

Q = daN/m f = mm L = mm

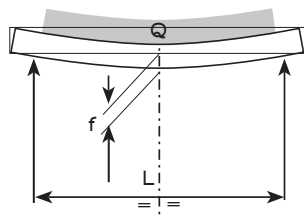

*Il carico Q è riferito ad un coefficiente di riempimento pari al 50% della sezione geometrica del canale. (Norme CEI 23-48).
*The load Q refers to a filling coefficient which is equal to 50% of the geometric section of trunking. (CEI 23-48 standard).

Carichi uniformemente distribuiti Q riferiti a frecce f pari o inferiori all'1% della distanza L tra gli appoggi per canale solo appoggiato.

Uniformly distributed loads Q with reference to arrows f equal to or less than 1% of the L distance between trunking supports with trunking just leaning.

2.4.14



www.canalplast.it - info@canalplast.it

INSTALLAZIONI / INSTALLATIONS

CANALPLAST

MINICANALI, CANALI PER IMPIANTI, CANALI PORTAUTENZE
MINITRUNKINGS, CABLE DUCTINGS, INSTALLATION TRUNKINGS

DIMENSIONI E DISPOSIZIONE GUIDE SUL FONDO PER I SEPARATORI.



SIZES AND LAYOUT OF THE RAILS ON THE BOTTOM FOR THE SEPARATORS.

Il canale si fissa a parete con tasselli TS, 2/4 per metro per misure piccole, 4/8 per metro per misure più grandi.

Trunking is fastened to the wall by TS nogs, 2/4 per meter for the smaller sizes, 4/8 per meter for the larger sizes.

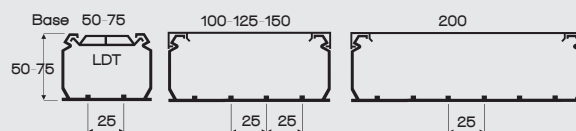

Dimensioni canale Trunking dimensions	N° scomparti N° compartments	Sezione / section mm ²							
		LDS	A	B	C	D	E	F	G
50 x 50	3	538	1050	538	-	-	-	-	-
75 x 50	3	1032	1050	1030	-	-	-	-	-
100 x 50	5	560	1050	1050	1050	560	-	-	-
125 x 50	5	1100	1050	1050	1050	1100	-	-	-
150 x 50	5	1585	1050	1050	1050	1585	-	-	-
200 x 50	7	1670	1050	1050	1050	1050	1050	1670	1670
75 x 75	3	1640	1610	1640	-	-	-	-	-
100 x 75	5	920	1610	1610	1610	920	-	-	-
125 x 75	5	1760	1610	1610	1610	1760	-	-	-
150 x 75	5	2557	1610	1610	1610	2557	-	-	-
200 x 75	7	2707	1610	1610	1610	1610	1610	2707	2707
	LDSC	A	B	C	D				
50 x 50	2	998	998	-	-	-	-	-	-
75 x 50	2	1482	1482	-	-	-	-	-	-
100 x 50	2	2060	2060	-	-	-	-	-	-
	3	1055	2010	1055	-	-	-	-	-
125 x 50	2	2600	2600	-	-	-	-	-	-
	3	1595	2010	1595	-	-	-	-	-
150 x 50	2	3085	3085	-	-	-	-	-	-
	3	2080	2010	2080	-	-	-	-	-
200 x 50	3	3215	2010	3215	-	-	-	-	-
	4	2210	2010	2010	2210	-	-	-	-
75 x 75	2	2370	2370	-	-	-	-	-	-
100 x 75	2	3260	3260	-	-	-	-	-	-
	3	1682	3155	1682	-	-	-	-	-
125 x 75	2	4100	4100	-	-	-	-	-	-
	3	2522	3155	2522	-	-	-	-	-
150 x 75	2	4897	4897	-	-	-	-	-	-
	3	3320	3155	3320	-	-	-	-	-
200 x 75	3	5080	3155	5080	-	-	-	-	-
	4	3502	3155	3155	3502	-	-	-	-

LDS

Separatore laterale.
Lateral separator.

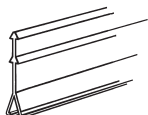

LDSC

Separatore centrale.
Central separator.

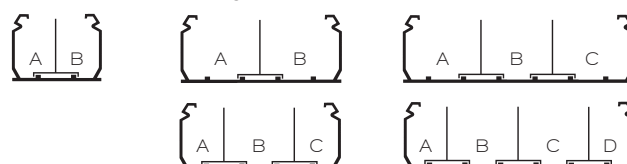
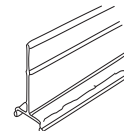
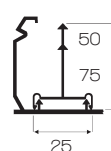

DM100

Scatola portautenze per apparecchiature con interasse 60-83,5 mm (2-3 moduli).
Socket point for equipments with interaxis 60-83,5 mm 2-3 modulus.
116x70x60 mm

Per canali Tipo G / For Type G trunkings

DM100 100 - 120 - 150 - 200 x H60
DM104 100 - 80 x H40
DM108 100 - 120 - 150 - 200 x H80

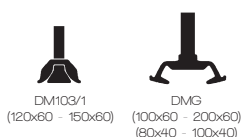
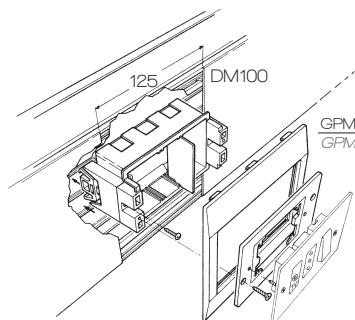

Sezione d'ingombro 3790 mm² da detrarre alla sezione utile del canale.
Section 3790 sq. mm to be subtracted from usable trunking section.

Per canali LINEADIN / For LINEADIN trunkings

DM100 100 - 125 - 150 - 200 x H50

LDM Placca porta mostrine
LDM Panel points packets

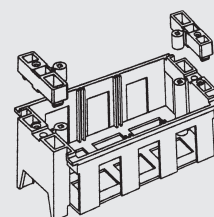

Tutti i canali
All the trunkings

DM105

Porta apparecchiature modulari (17,5). Max. N° 5.
Holding device for 17,5 modular switches. Max 5
116x40x59 mm

Per canali Tipo G / For Type G trunkings

150 - 200 x H60

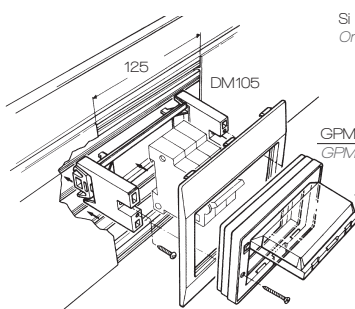

Si fissa solo con l'impiego di DM075
Only attached using DM075



Utilizzare i ganci per i tipi di canale indicati.
Use the hooks for the shown type of trunkings.

Sezione d'ingombro 3790 mm² da detrarre alla sezione utile del canale.
Section 3790 sq. mm to be subtracted from usable trunking section.

Per canali LINEADIN / For LINEADIN trunkings

150 - 200 x H50

LDM Placca porta mostrine
LDM Panel points packets

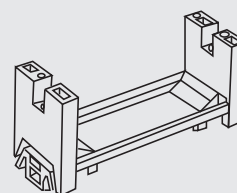

Tutti i canali
All the trunkings

DMF

Porta fascette che si monta a scatto negli appositi ganci sul fondo interno del canale.

Materiale: Nylon

Cable tie holder which can be snapped on all ducts having a base rail.

Material: Nylon

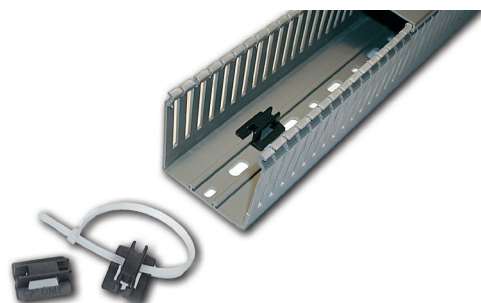

LDG

Giunto canali e snodo.

Misure esterne dalla base del canale per forare e fissare LDG. Forare le pareti del canale con punta $\varnothing 8$. Per formare lo snodo, spezzonare a metà il giunto.

Trunkings joint and articulated coupling.

External dimensions from the base of the trunking for drilling and fixing LDG. Drill with a 8 mm dia bit. To have the articulation, cut the joint in the middle.

Codice Code	BxH mm BxH mm	Per canali H For duct H
LDG50	32x200	40
LDG75	58x175	75

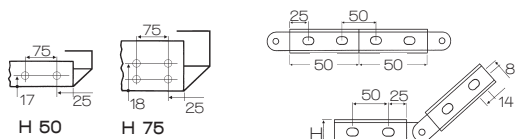

FMC

Fermacavo universale per canali H.60/80.

Applicato sulle guide dei canali impedisce lo spostamento accidentale dei cavi. Può contenere 3 cavi (massimo 5mm di diametro) per ogni foro.

Universal cable-holder. For wire ducts H. 60/80.

Application on the built-in rail of the duct to avoid accidental pulling of the wires. It can contain 3 wires (of maximum 5mm of diameter) for each hole.

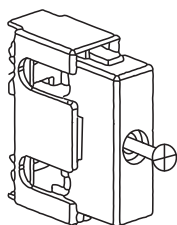

MOSTRINE E PORTAMOSTRINE. PANELS AND FRONT PLATES HOLDERS.

DM071

Mostrina cieca per presa telefonica e accessorio DM082.

Closed plate for It. phone socket and DM082 accessory.

120x85 mm

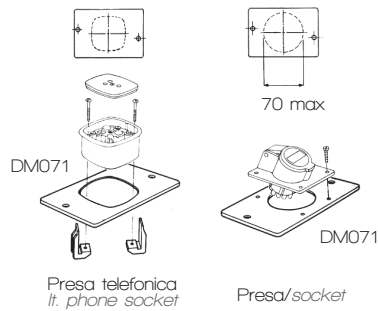
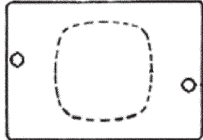

DM072

Mostrina per 4 moduli Gewiss - Ave - Ticino Int. - Ticino TT - Vimar Plana o 2 prese Schuko.

Plate for 4 Gewiss - Ave - Ticino Int. - Ticino TT Vimar Plana modules or 2 Schuko socket.

120x85 mm

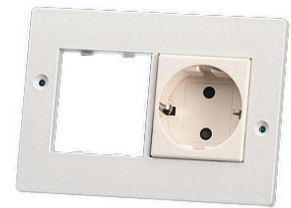
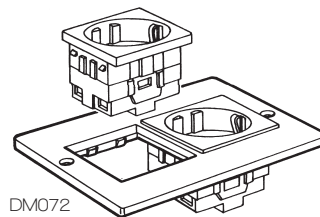
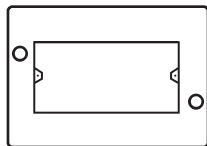

DM073

Mostrina per apparecchiature con interasse 83,5 mm.

Plate for sockets with interaxis 83,5 mm.

120x85 mm

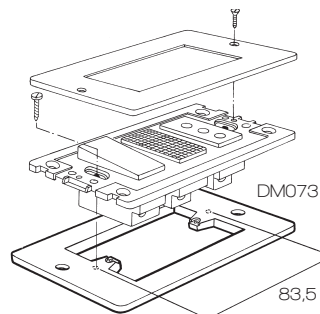
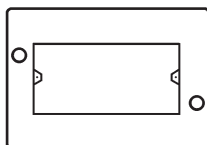

MOSTRINE E PORTAMOSTRINE. PANELS AND FRONT PLATES HOLDERS.

DM0736

Mostrina per il montaggio di apparecchiatura con interasse 55 e 60 mm.

Plate for fitting equipments with interaxis 55 and 60 mm.
120x85 mm

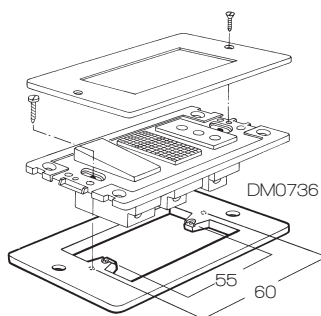
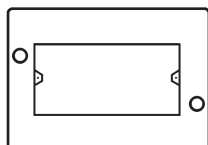

DM075

Mostrina per il montaggio in orizzontale di max 5 apparecchiature modulari (17,5) su guida DIN 46277/3. (Solo con DM105) completa di : coperchio trasparente, profilato omega, distanziale, 3 viti met. di fissaggio.

Plate for horizontal installation of max 5 modular equipment units (17,5) on DIN 46277/3 guide. (Only with DM105) complete with: transparent cover, omega profile, spacer, 3 metal fixing screws.

120x85 mm

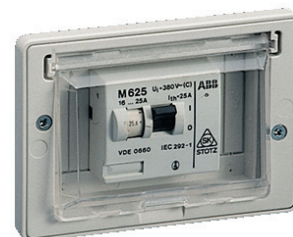
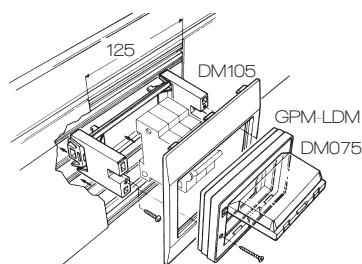
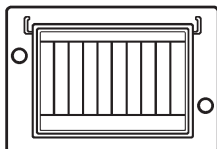

DM082

Adattatore per connettori EDP. completo di: placchetta per connettori D-SUB (a vaso) 9/15/25 contatti, placca. per connettori DIN, placchetta senza fori per connettori.

Si utilizza anche con porta mostrine LDM205 e GPM20.



IT sockets adaptor. Includes:

plate for D-SUB computer links (bowl) 9/15/25 contacts, plate for two DIN computer links, plate without holes for computer links.

Use with front plate holder LDM205 and GPM20 too.

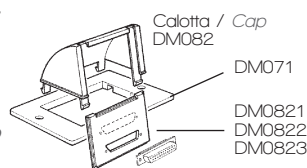
120x85 mm



-  DM0821 Per connettori D-SUB (a vaschetta), 9-15-25 contatti
For D-SUB computer links (bowl), 9-15-25 pins.
-  DM0822 Per 2 connettori DIN
For 2 DIN computer links
-  DM0823 Senza fori
Without holes

LDM per canali LINEADIN / for LINEADIN trunkings.

Placche porta mostrine per canali LINEADIN

Per il montaggio delle mostrine DM071, DM072, DM073, DM075 (con distanziatore) e adattatori per connettori EDP DM082 su canali Lineadin 105-125-155-205xH50. Si incastrano a scatto sul canale.

Front plate panel point for LINEADIN trunkings.

For mounting of DM071, DM072, DM073, DM075, with spacer and It. sockets adaptors DM082 on Lineadin 105-125-155-205xH50 trunkings.

Click on the trunking.

Calotta / Cap DM082

